

French Classique Collection

Arches



Visit our [showroom](#) at 83-85 Boundary Road, Mortdale NSW 2223

Tel: +612 9153 9326

Fax: +612 9534 6532

Email: sales@baileyinteriors.com.au

Web: www.baileyinteriors.com.au

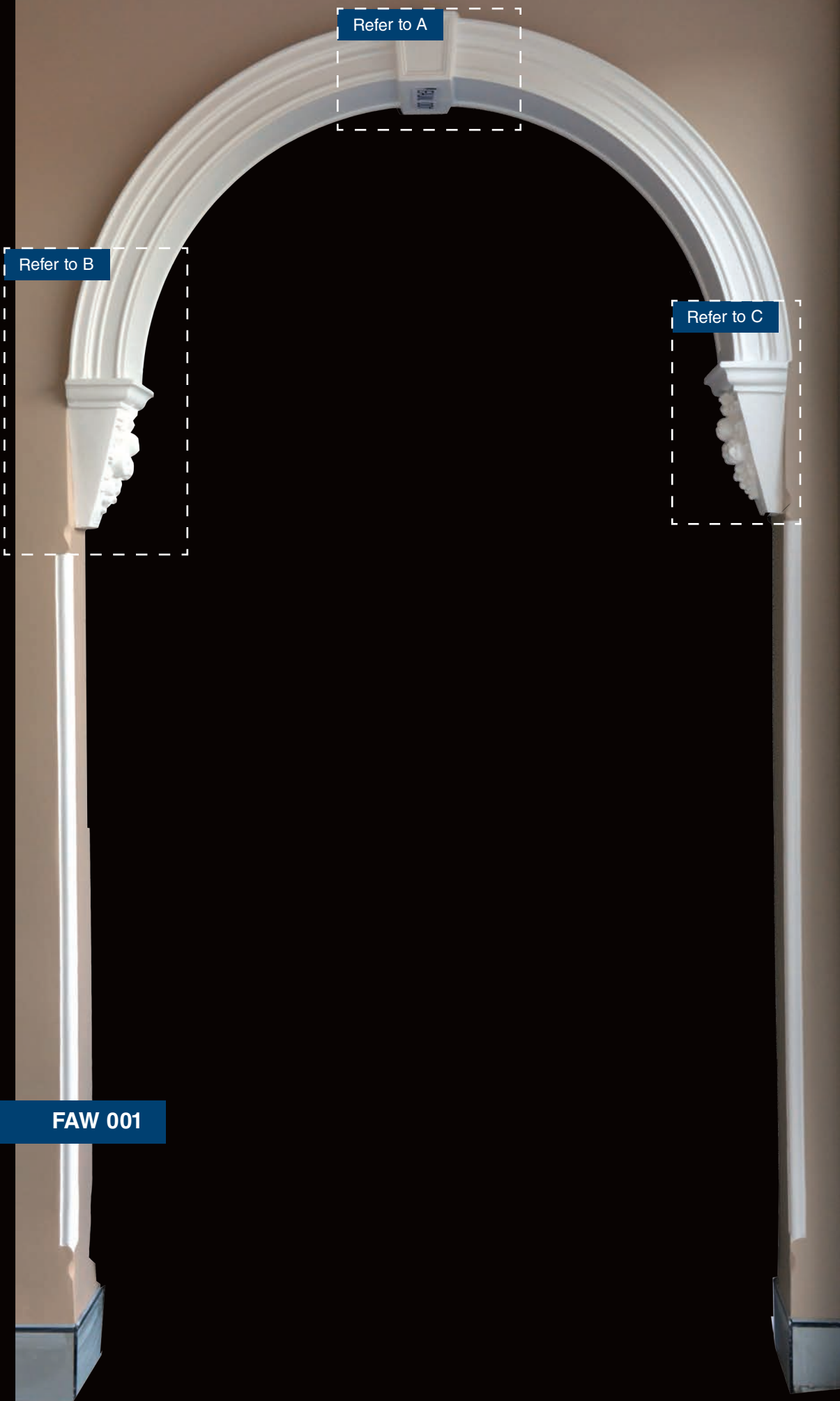

FAW 001

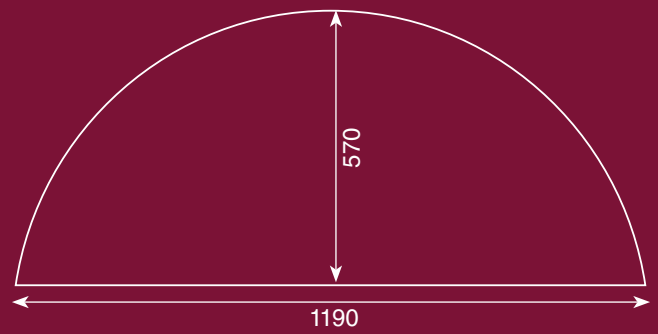
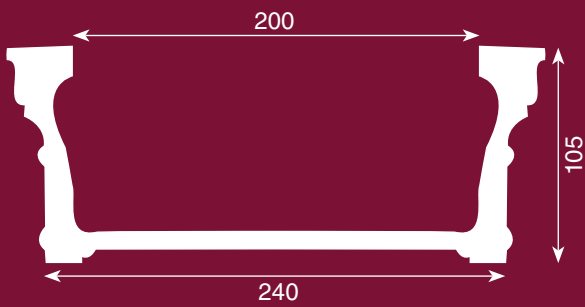

Arch Profile

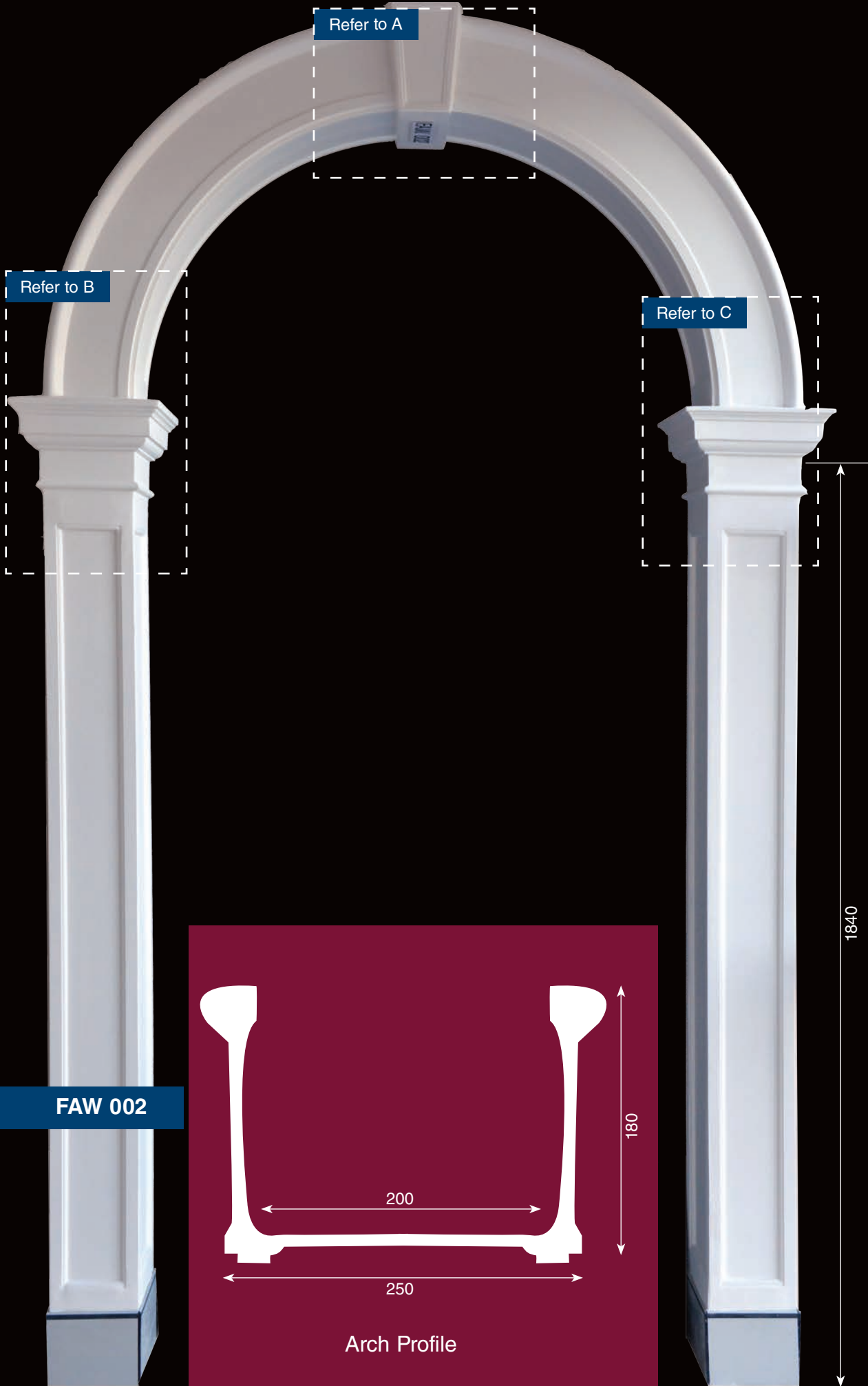

FAW 002

1840

180

200

250

Arch Profile

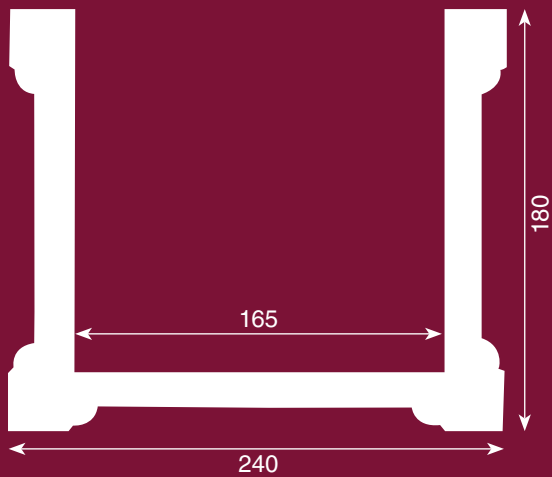
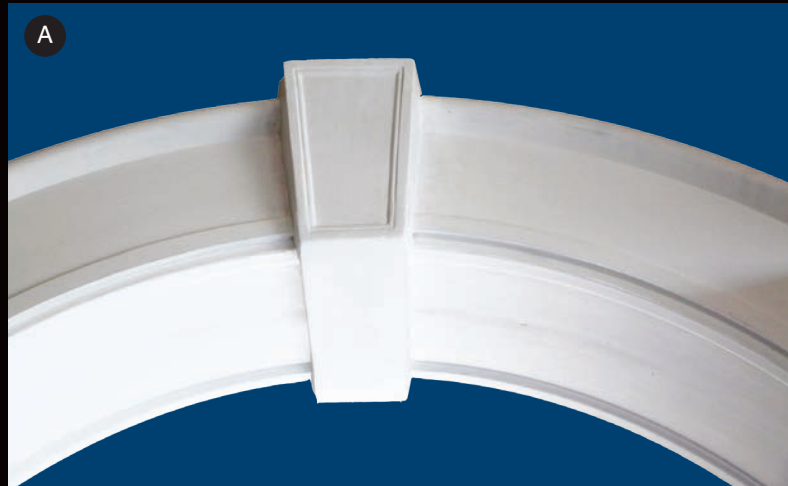

Column Profile

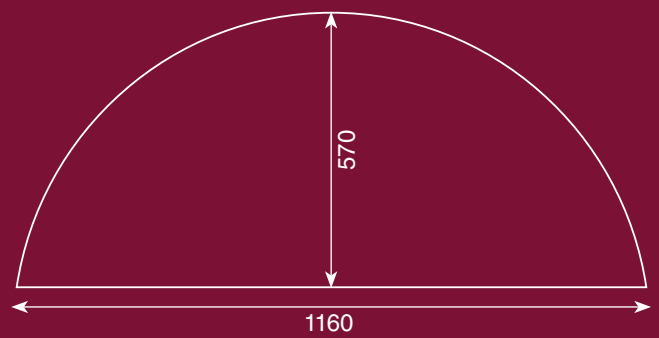

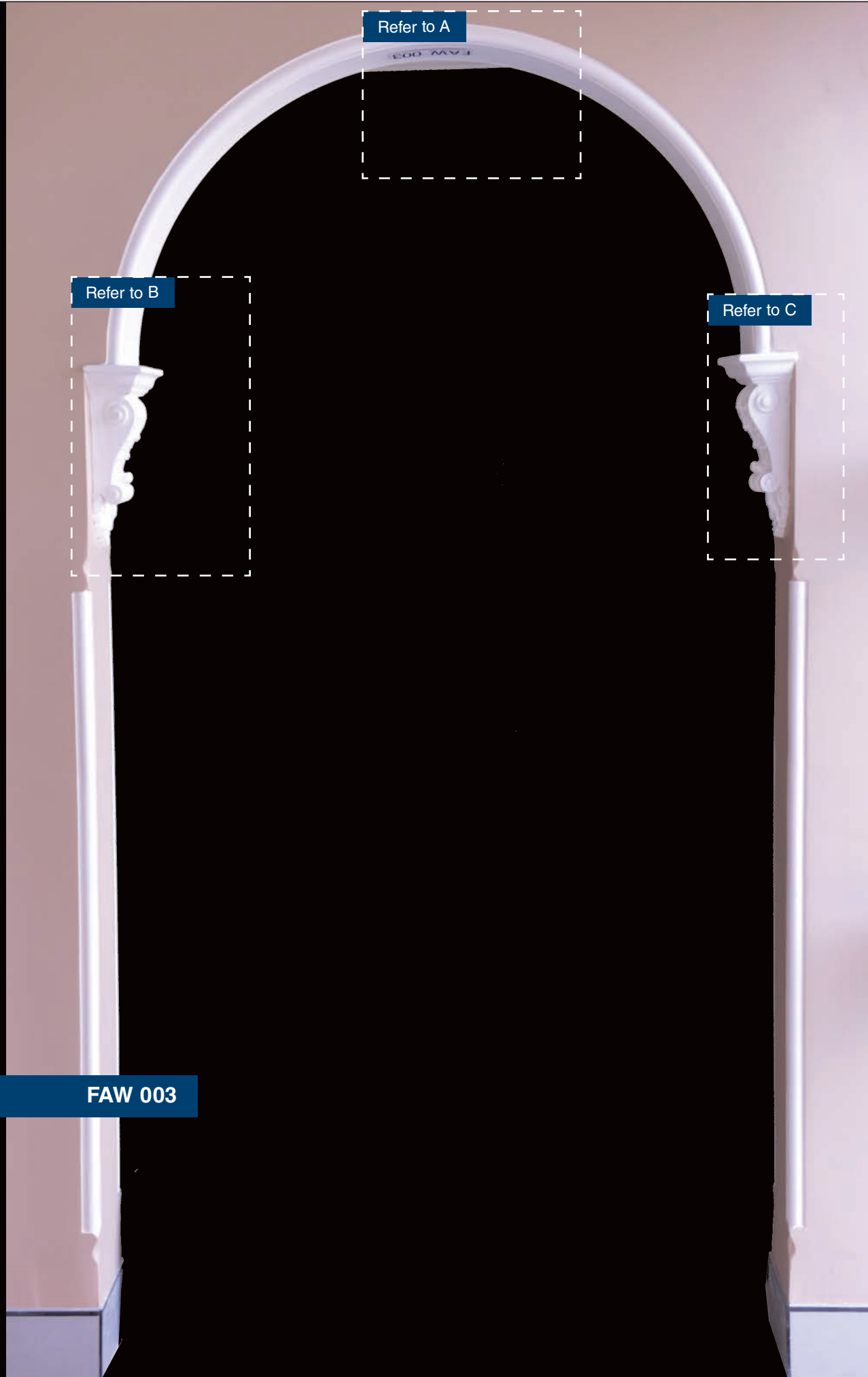

FAW 003

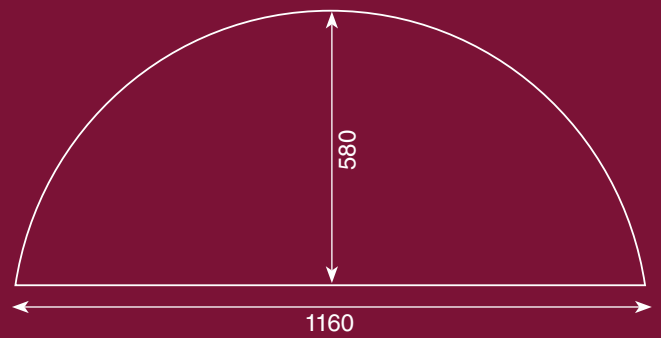
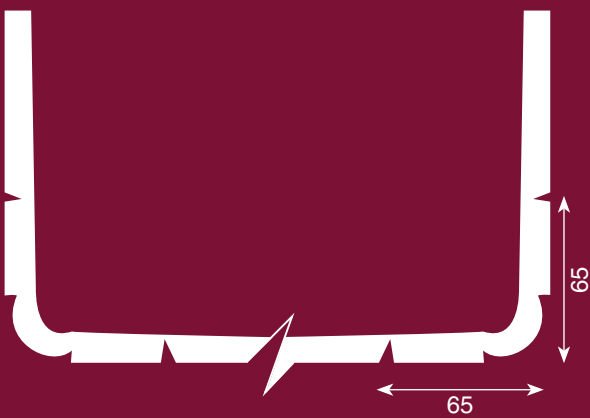

Arch Profile

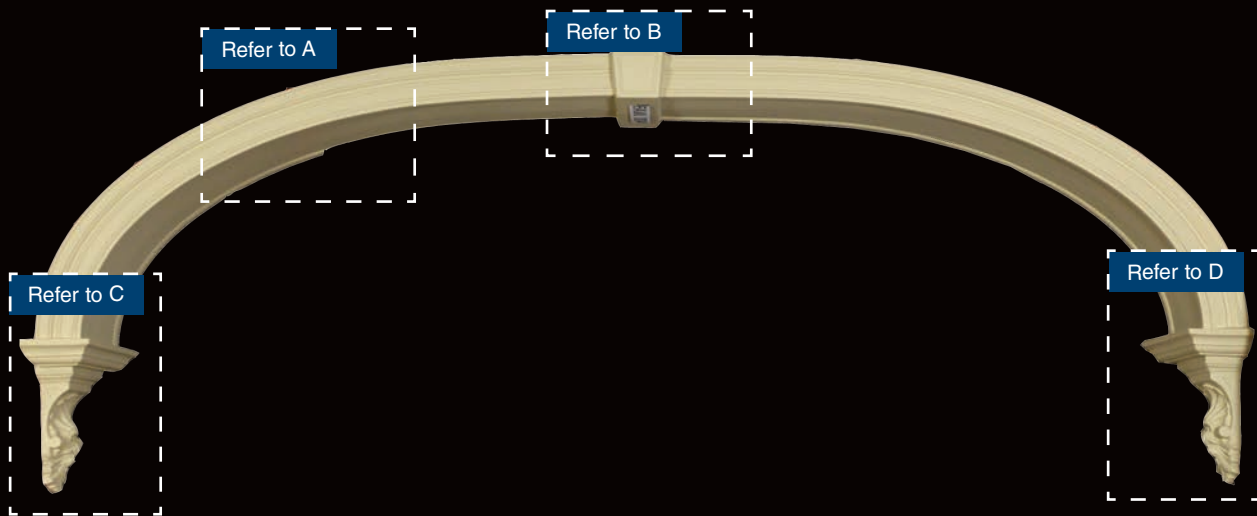

FAW 004

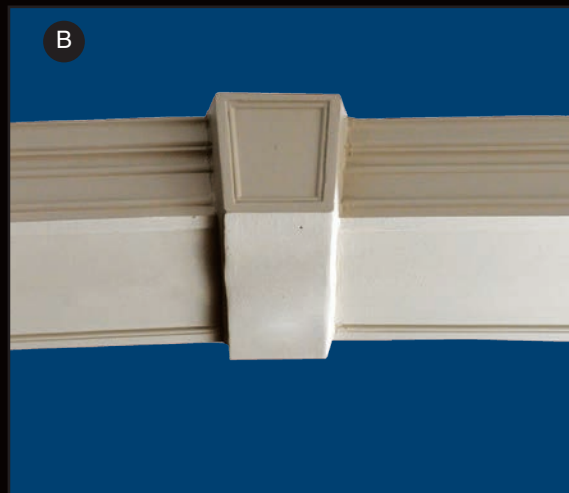

Elliptical Arch (135, 150, 210, 230)

Arch set includes: 2x arch sections 2x plinths
2x corbels and key stone .

These arches can be made to custom size
wall thickness.

These arches can be made to adjustable
lengths up to 2500 meter lengths

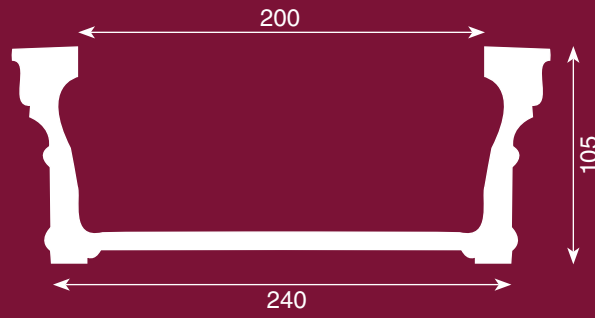

Arch Profile

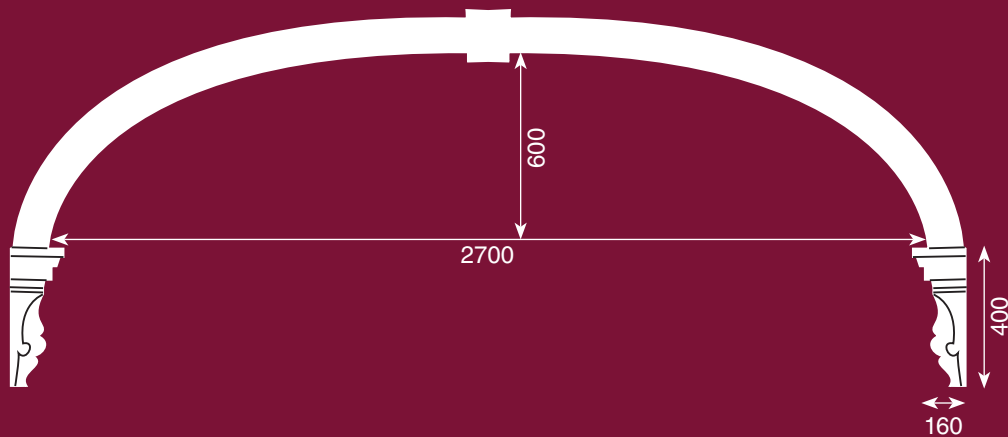

BA 005

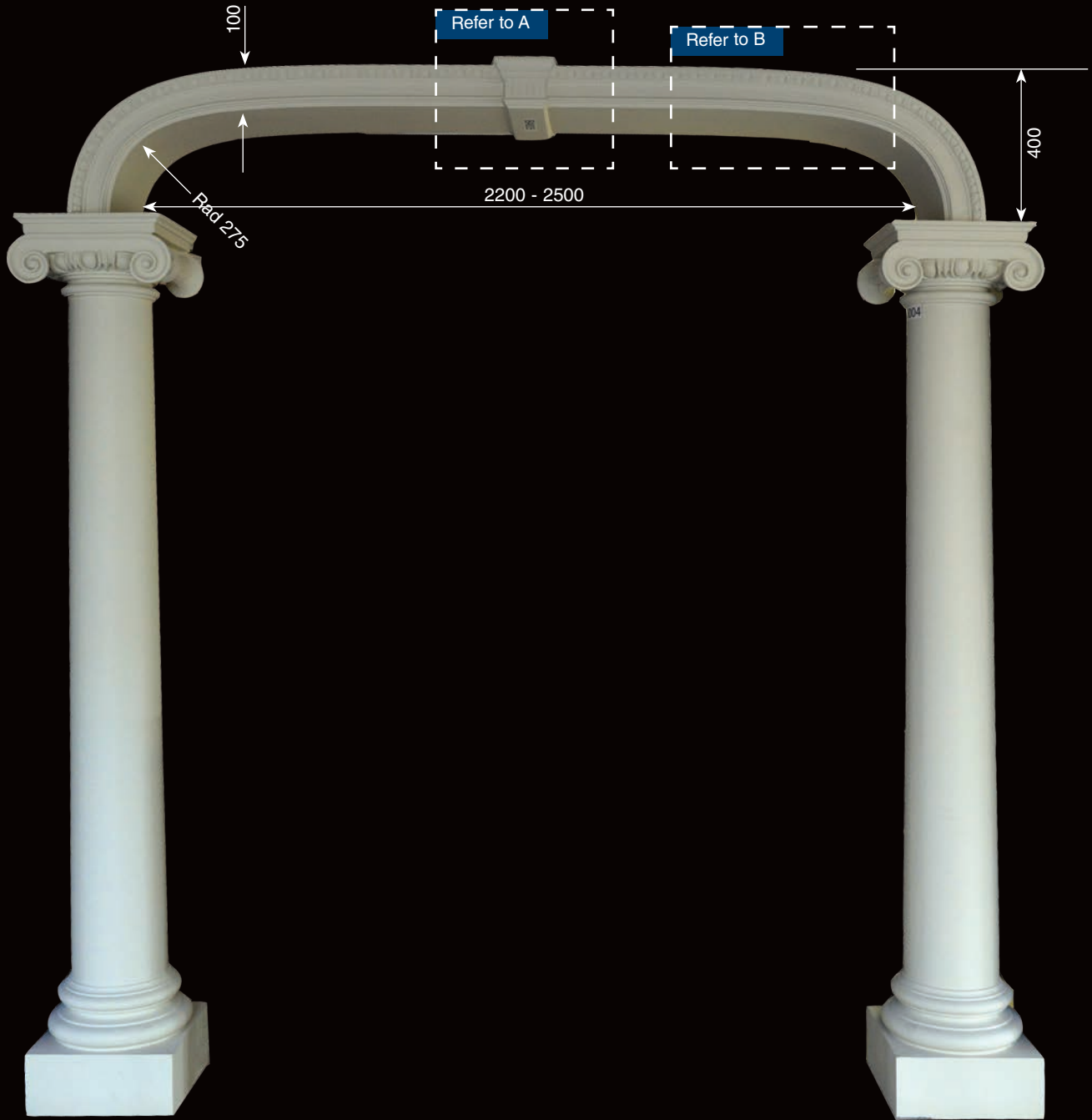

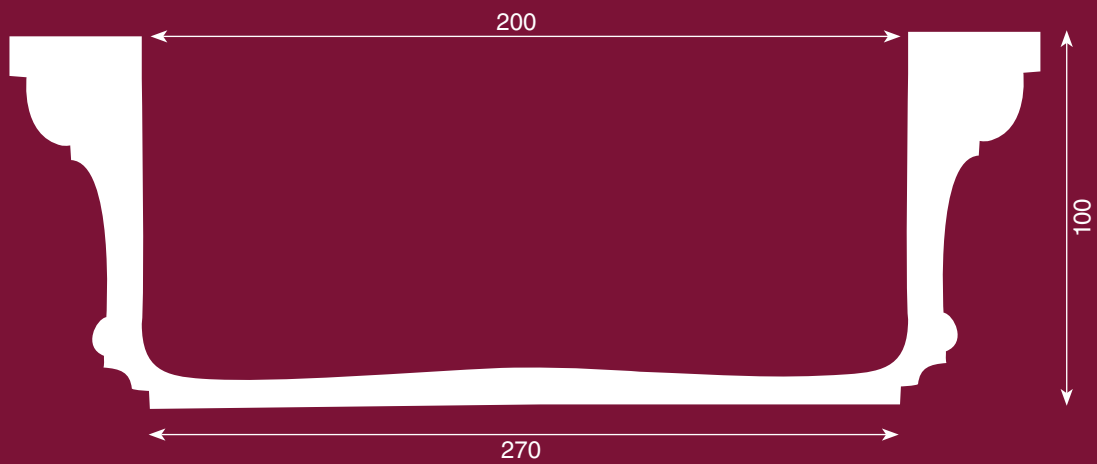
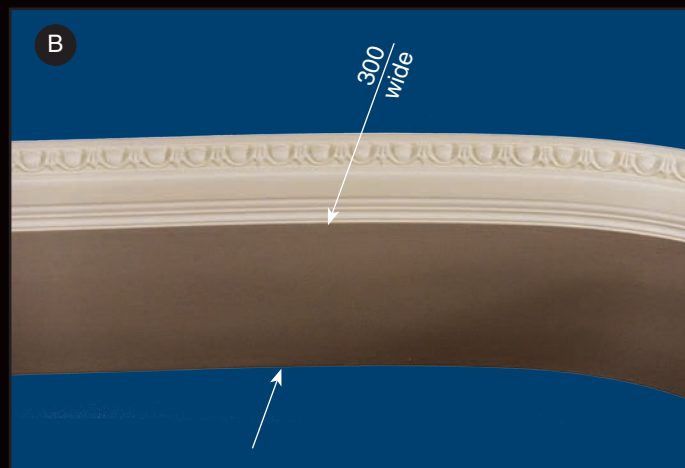
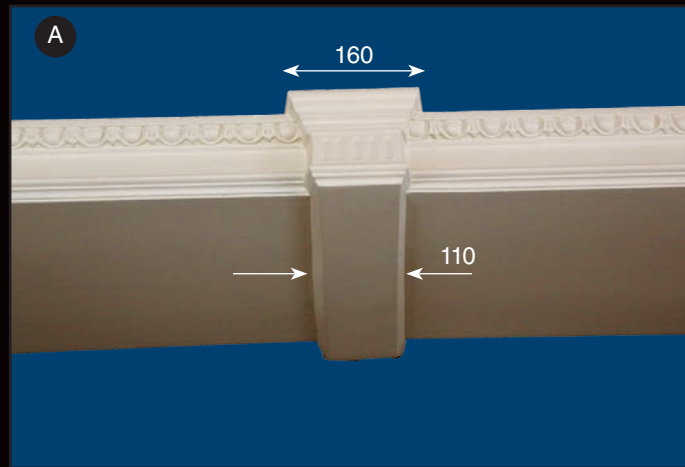

Arch Profile

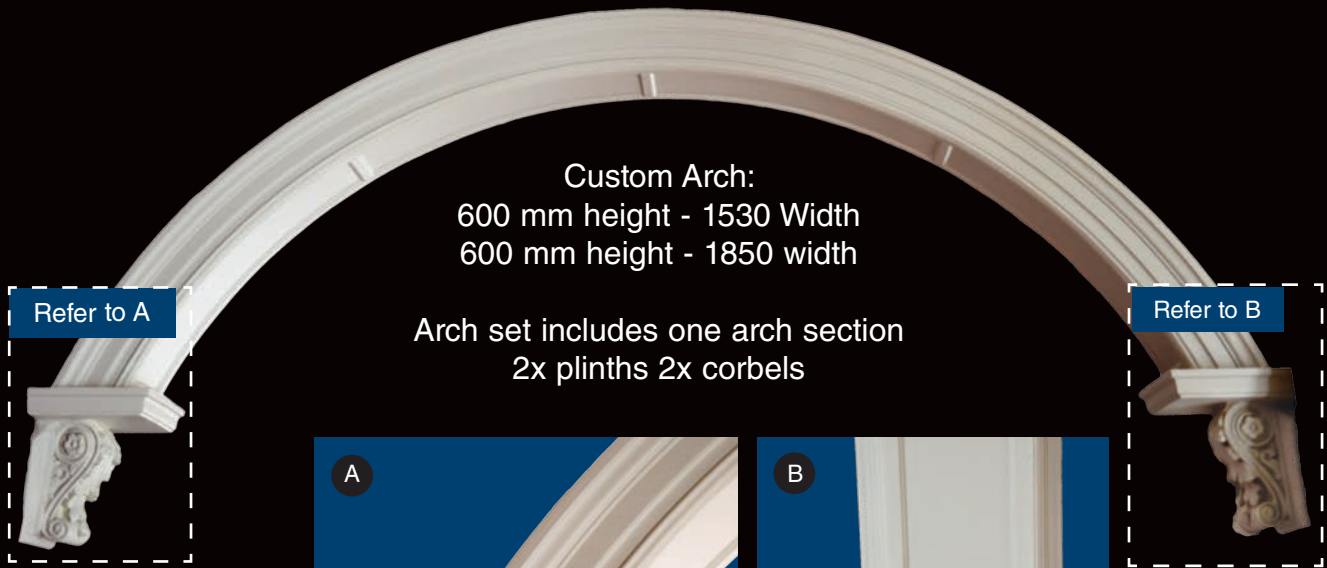

Custom Arch:
600 mm height - 1530 Width
600 mm height - 1850 width

Arch set includes one arch section
2x plinths 2x corbels

Refer to A

Refer to B



FAW 005

Arch Profile

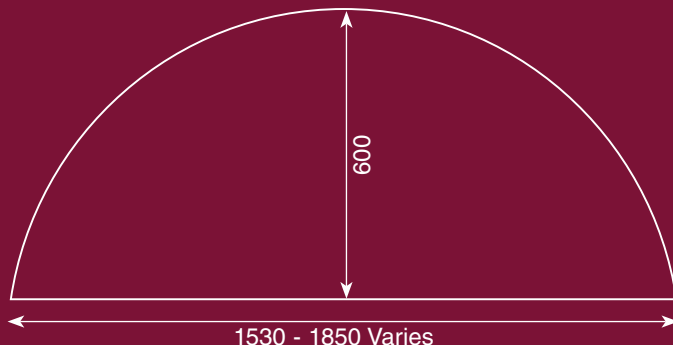
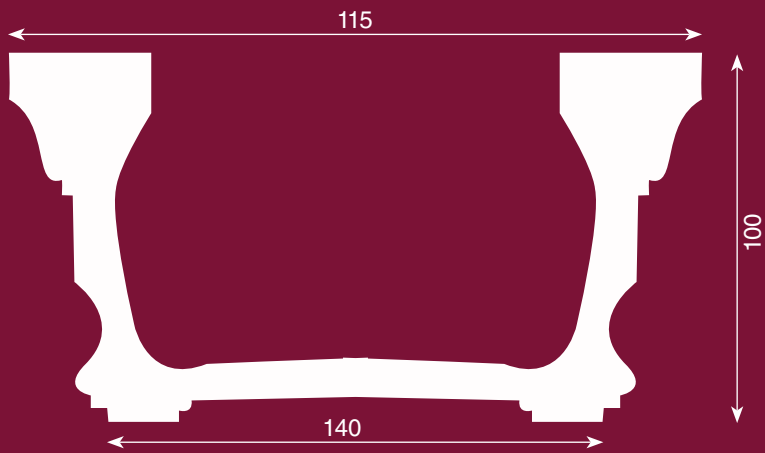



Bailey Interiors has been supplying the building and architectural industry with the finest quality cornices for over seventy years. The French Classique collection features outstanding quality, elegant style, finish and unbeatable value.

Green Product Sheet

Made to last a lifetime

Bailey Interiors Architectural products are made of the finest Gypsum. They have timeless features and built for longevity.

Made of natural Gypsum

Bailey Interiors Architectural products are a unique blend of at least 75% naturally occurring Gypsum.

Energy and water-efficient

Bailey Interiors Architectural products are more energy and water-efficient than alternative acrylic and resin based products. Bailey Interiors have installed a unique water recycling process whereby excess water from the production runs are recycled and used again in further production. The high Gypsum content also outperforms acrylic, which quickly dissipates water heat, resulting in reduced use of water.

Minimal manufacturing impact

Bailey Interiors Architectural products are created by a combination of machine made and hand made production methods. This combination allows for a better quality product as compared with acrylic, and composite products.

Bailey Interior's Architectural products also use significantly less energy than electrically high – heat ovens. They use a combination of natural drying and gas operated ovens.

Additionally Bailey Interiors Architectural products are hand finished by craftsmen, further reducing reliance on non renewable resources.

Minimal impact on the environment

Bailey Interiors Architectural Products are made of the finest Gypsum.

Bailey Interiors have installed two filtration units on top of the bulk silo bin. These units absorb any excess plaster dust from going in to the atmosphere whilst the plaster silo is being loaded with plaster which is pumped by compressed air from the bulk plaster truck. These filtration units allow for the air to remain clean and clear which does not impact on the environment.

Recycled Shipping

Bailey Interiors Architectural products are shipped on pallets made of reclaimed wood, with strapping made from recycled bottles.

Customers who choose Bailey Interiors Architectural products know they are making an environmentally good choice because they are making a purchase lasting a lifetime.

Recycled Waste

Bailey Interiors Architectural products are more conscious of material waste. A large proportion of our product waste is recycled back into the production process, through our new cornice machine equipment.